



2400 Series
AEX2400 / TDM2400P



User Manual



Digium, Inc.
445 Jan Davis Drive
Huntsville, AL 35806
United States
Main Number: 1.256.428.6000
Tech Support: 1.256.428.6161
U.S. Toll Free: 1.877.344.4861
Sales: 1.256.428.6262
www.digium.com
www.asterisk.org
www.asterisknow.org

© Digium, Inc. 2013
All rights reserved.

No part of this publication may be copied, distributed, transmitted, transcribed, stored in a retrieval system, or translated into any human or computer language without the prior written permission of Digium, Inc.

Digium, Inc. has made every effort to ensure that the instructions contained in this document are adequate and error free. The manufacturer will, if necessary, explain issues which may not be covered by this documentation. The manufacturer's liability for any errors in the documents is limited to the correction of errors and the aforementioned advisory services.

This document has been prepared for use by professional and properly trained personnel, and the customer assumes full responsibility when using it.

Adobe and Acrobat are registered trademarks, and Acrobat Reader is a trademark of Adobe Systems Incorporated.

Asterisk, Digium, Switchvox, and AsteriskNOW are registered trademarks and Asterisk Business Edition, AsteriskGUI, and Asterisk Appliance are trademarks of Digium, Inc.

Any other trademarks mentioned in the document are the property of their respective owners.

Compliance Information

Compliance information for this product is available at <http://www.digium.com/ccs-compliance>.

Introduction to 2400 Series Documentation

This manual contains product information for the 2400 Series card. Be sure to refer to any supplementary documents or release notes that were shipped with your equipment. The manual is organized in the following manner:

Chapter/ Appendix	Title	Description
1	Overview	Identifies the card and type of modules you received with your 2400 Series card. This chapter covers applications and uses of the 2400 Series card in the real world.
2	Card Installation	Provides instructions for installing the card in your PC, acquiring correct drivers, and checking device compatibility.
3	Configuration	Provides examples for configuring dial plan options.
4	FXS and FXO Explained	Describes the FXO (Foreign Exchange Office) and FXS (Foreign Exchange Station) modules and their significance.
5	Troubleshooting	Explains resolutions to common problems and frequently asked questions pertaining to card installation and usage.
A	Pin Assignments	Lists the connectors and pin assignments.
B	Specifications	Details card specifications.
C	Glossary and Acronyms	A list of terms and acronyms used throughout this manual.

Symbol Definitions



Caution statements indicate a condition where damage to the unit or its configuration could occur if operational procedures are not followed. To reduce the risk of damage or injury, follow all steps or procedures as instructed.



The ESD symbol indicates electrostatic sensitive devices. Observe precautions for handling devices. Wear a properly grounded electrostatic discharge (ESD) wrist strap while handling the device.



The Electrical Hazard Symbol indicates a possibility of electrical shock when operating this unit in certain situations. To reduce the risk of damage or injury, follow all steps or procedures as instructed.

Important Safety Instructions

User Cautions



Warning

This card must be used with the PC lid screwed down. Telecommunications network voltages exist inside the PC! The PC must be shut down and telecommunications line connection shall be removed before opening the PC.



Electrical Shock.

To reduce the risk of injury, damage to the unit or your equipment, do not attempt to touch the modules while they are powered. The case should be securely closed before power is applied to the unit.



Alarm Dialing Equipment.

If your home has specially wired alarm equipment connected to the telephone line, ensure the installation of the 2400 Series does not disable your alarm equipment. If you have questions, consult your telephone company or a qualified installer.



Servicing.

Do not attempt to service this card unless specifically instructed to do so. Do not attempt to remove the card from your equipment while power is present. Refer servicing to qualified service personnel.



Water and Moisture.

Do not spill liquids on this unit. Do not operate this equipment in a wet environment.



Heat.

Do not operate or store this product near heat sources such as radiators, air ducts, areas subject to direct, intense sunlight, or other products that produce heat.



Caution.

To reduce the risk of fire, use only No. 26 AWG or larger telecommunication wiring for network connections.

User Cautions



Caution.

This card is not intended for home use. It must be used in restricted access locations and installed in UL Listed I.T.E. only.



Static Electricity.

To reduce the risk of damaging the unit or your equipment, do not attempt to open the enclosure or gain access to areas where you are not instructed to do so. Refer servicing to qualified service personnel.

Save these instructions for future reference.

Service Personnel Cautions



Warning.

This card must be used with the PC lid screwed down. Telecommunications network voltages exist inside the PC! The PC must be shut down and telecommunications line connection shall be removed before opening the PC.



Electrical Shock.

To reduce the risk of injury, damage to the unit or your equipment, do not attempt to touch the modules while they are powered. The case should be securely closed before power is applied to the unit.



Servicing.

Disconnect telecommunications network cable before opening the cover or removing the card from the motherboard.



Labeling.

*For safety reasons, only connect equipment with a Telecommunications Compliance label. This includes customer equipment previously labelled **Permitted** or **Certified**.*



Caution.

Only connect regulatory equipment (approved for use in your specific country) to the telecommunications network voltage circuit ports.

Service Personnel Cautions



Caution.

This card is not intended for home use. It must be used in restricted access locations and installed in UL Listed I.T.E. only.

TABLE OF CONTENTS

Chapter 1	
Overview	13
Echo-Cancellation	17
What is Asterisk®?	18
Asterisk as a Switch (PBX)	18
Asterisk as a Gateway	18
Asterisk in the Call Center	19
Asterisk in the Network	19
Asterisk Everywhere	19
Chapter 2	
Card Installation	20
Unpacking the Card	21
Shipment Inspection	21
Module Identification	22
Card Identification	25
FXS and FXO Connection	27
Hardware Installation	29
Software Installation	32
Installing Asterisk	36
Chapter 3	
Configuration	38
Driver Configuration	39

Table Of Contents

Configuring Card Features	44
Voicemail	46
Testing Your Configuration	48
Chapter 4	
FXS and FXO Explained	50
Identification	50
FXS Module	50
FXO Module	50
Using Your 2400 Series Card	51
Chapter 5	
Troubleshooting	52
Appendix A	
Pin Assignments	57
Appendix B	
Specifications	58
Physical	58
Interfaces	58
Environment	59
Hardware and Software Requirements	59
Appendix C	
Glossary and Acronyms	61

List of Figures

Figure 1:	Sample Application - Channel Bank	14
Figure 2:	Sample Application - Legacy PBX	15
Figure 3:	Sample Application - Toll-bypass	15
Figure 4:	Sample Application - Analog to VoIP Transcoding	16
Figure 5:	TDM2400P Card (Model TDM2433E)	23
Figure 6:	AEX2400 Card (Model TDM2433E)	24
Figure 7:	Motherboard Slots	28
Figure 8:	Insert the Card	29
Figure 9:	Connect Power for FXS Quad Modules	30
Figure 10:	Example dmesg Screen Shot	43
Figure 11:	Sample Application	49

List of Tables

Table 1:	Example TDM2400P Card Configurations	25
Table 2:	Example AEX2400 Card Configurations	26
Table 3:	Card Identifiers	34
Table B-1:	Maximum Power Consumption	60

Chapter 1 Overview

The 2400 Series cards are versatile devices used for connecting your phone network to the PSTN (Public Switched Telephone Network) world. This is accomplished through phone lines connected to the FXO (Foreign Exchange Office) ports and phones connected via the FXS (Foreign Exchange Station) ports. The cards allow Asterisk to connect to your phone network, creating an office type telephony environment.

There are a variety of applications where the 2400 Series cards can prove useful. Some examples are provided in the following figures.

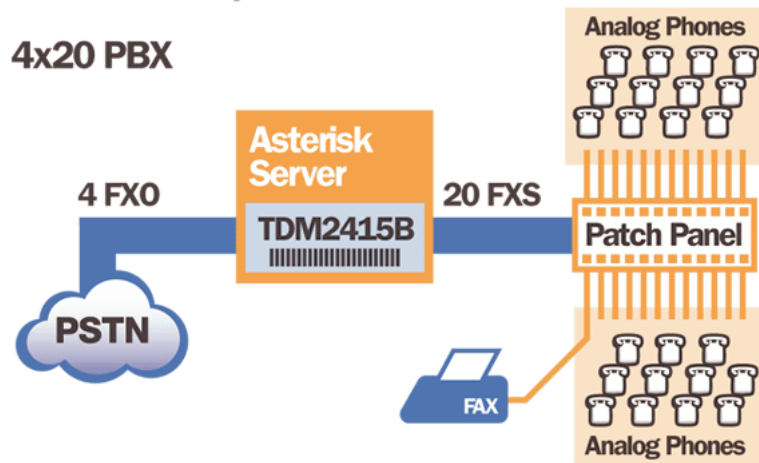

Figure 1: Sample Application - Channel Bank

Note: An FXS module should be connected only to a device that is located inside of the same building to minimize lightning exposure.

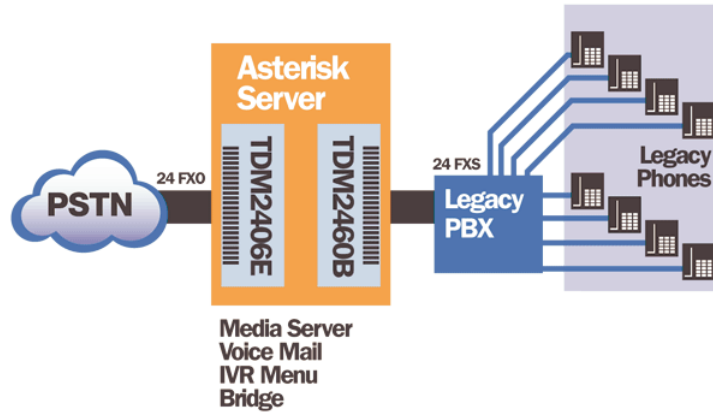

Figure 2: Sample Application - Legacy PBX

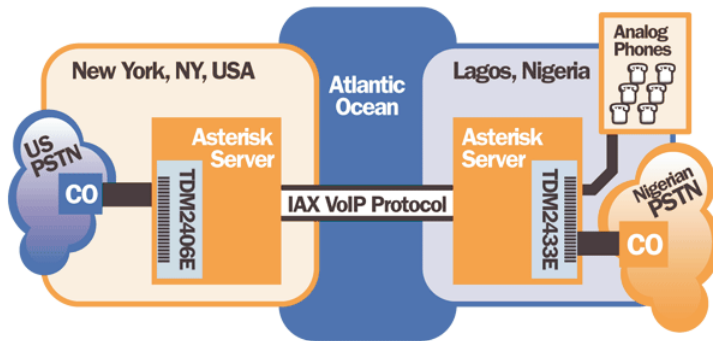

Figure 3: Sample Application - Toll-bypass

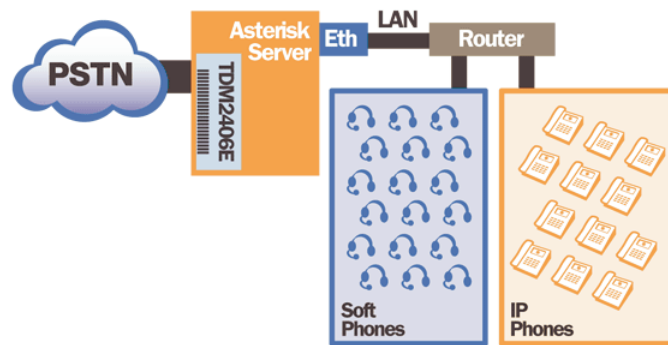

Figure 4: Sample Application - Analog to VoIP Transcoding

Echo-Cancellation

Users connecting their 2400 Series cards to the PSTN or other devices are likely to be placing calls that will result, at some point, in an unbalanced 4-wire/2-wire hybrid. The result of this hybrid is the reflection of a near-end echo to the calling party. Elimination of this echo is the responsibility of echo cancellation.

The 2400 Series cards, unless otherwise equipped, utilize Asterisk to perform software-based echo cancellation. Asterisk maintains a number of open source echo cancelers. These open source echo cancelers provide a moderate level of echo cancellation, but are not capable of dealing with higher levels of, or more advanced, echoes.

Digium recommends that those users concerned about echo cancellation purchase the VPMOCT032 hardware echo cancellation module. The VPMOCT032 may be combined with both the TDM2400P and AEX2400.

The VPMOCT032 is designed to handle up to 128ms of echo cancellation across all channels and provides a G.168 echo cancellation solution.

What is Asterisk®?

Asterisk is the world's leading open source telephony engine and tool kit. Offering flexibility unheard of in the world of proprietary communications, Asterisk empowers developers and integrators to create advanced communication solutions...for free. Asterisk is released as open source under the GNU General Public License (GPL), and it is available for download free of charge. Asterisk is the most popular open source software available, with the Asterisk Community being the top influencer in VoIP.

Asterisk as a Switch (PBX)

Asterisk can be configured as the core of an IP or hybrid PBX, switching calls, managing routes, enabling features, and connecting callers with the outside world over IP, analog (POTS), and digital (T1/E1) connections.

Asterisk runs on a wide variety of operating systems including Linux, Mac OS X, OpenBSD, FreeBSD, and Sun Solaris. It provides all of the features you would expect from a PBX including many advanced features that are often associated with high end (and high cost) proprietary PBXs. Asterisk's architecture is designed for maximum flexibility and supports Voice over IP in many protocols, and can interoperate with almost all standards-based telephony equipment using relatively inexpensive hardware.

Asterisk as a Gateway

It can also be built out as the heart of a media gateway, bridging the legacy PSTN to the expanding world of IP telephony. Asterisk's modular architecture allows it to convert between a wide range of communications protocols and media codecs.

Asterisk as a Feature/Media Server

Need an IVR? Asterisk's got you covered. How about a conference bridge? Yep. It's in there. What about an automated attendant? Asterisk does that too. How about a replacement for your aging legacy voicemail system? Can do. Unified messaging? No problem. Need a telephony interface for your web site? Ok.

Asterisk in the Call Center

Asterisk has been adopted by call centers around the world based on its flexibility. Call center and contact center developers have built complete ACD systems based on Asterisk. Asterisk has also added new life to existing call center solutions by adding remote IP agent capabilities, advanced skills-based routing, predictive and bulk dialing, and more.

Asterisk in the Network

Internet Telephony Service Providers (ITSPs), competitive local exchange carriers (CLECS) and even first-tier incumbents have discovered the power of open source communications with Asterisk. Feature servers, hosted services clusters, voicemail systems, pre-paid calling solutions, all based on Asterisk have helped reduce costs and enabled flexibility.

Asterisk Everywhere

Asterisk has become the basis for thousands of communications solutions. If you need to communicate, Asterisk is your answer. For more information on Asterisk, visit <http://www.asterisk.org> or <http://www.digium.com>.

Chapter 2 Card Installation

This chapter provides the following information:

- **Unpacking the Card** on page 21
- **Shipment Inspection** on page 21
- **Module Identification** on page 22
- **Card Identification** on page 25
- **FXS and FXO Connection** on page 27
- **Slot Compatibility** on page 27
- **Hardware Installation** on page 29
- **Software Installation** on page 32
- **Installing Asterisk** on page 35

Unpacking the Card

When you unpack your card, carefully inspect it for any damage that may have occurred in shipment. If damage is suspected, file a claim with the carrier and contact the reseller from which the card was purchased, or contact Digium Technical Support (+1.256.428.6161). Keep the original shipping container to use for future shipment or proof of damage during shipment.

Note: Only qualified service personnel should install the card. Users should not attempt to perform this function themselves. The installer must ensure that the equipment is permanently connected equipment, pluggable type B or connected to a socket-outlet that has been checked to ensure that it is reliably earthed in accordance with the National Electrical Code.



This card is intended for installation in a Restricted Access Location (RAL) only.

Shipment Inspection

The following items are included in shipment of a 2400 Series card:

- 2400 Series card (TDM2400P or AEX2400)
- FXO and/or FXS quad module(s) (depending on configuration)

Module Identification

The 2400 Series card ships with FXO and/or FXS quad modules in place. These are identified by their color. Take a moment to identify which quad modules were shipped with your card.

- FXO (Foreign Exchange Office) quad modules are Red
- FXS (Foreign Exchange Station) quad modules are Green

See Figure 5 on page 23 for an example of the card shown with three of each quad module.

Note: It is important to identify the type and location of your 2400 Series quad modules. You will need this information during the Asterisk configuration.

There are multiple configurations in which the 2400 Series card may be purchased. Each configuration consists of one to six FXS and/or FXO quad modules. See Table 1 on page 25 for a complete list of possible configurations.

The 2400 Series cards may also be combined with Digium's hardware-based echo canceler, model VPMOCT032. See Figure 6 on page 24 for an example of the AEX2400 card shown with one of each quad analog module and the echo cancellation module.

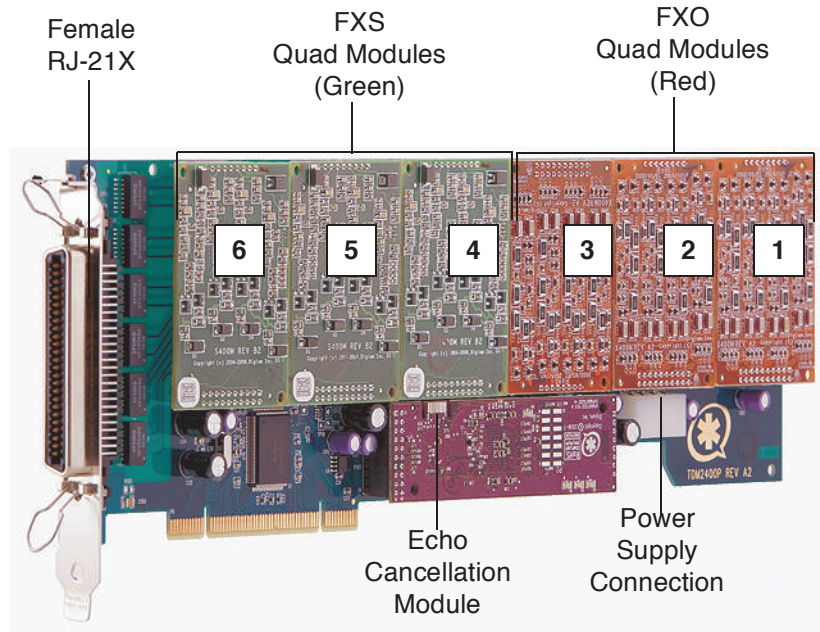

Figure 5: TDM2400P Card (Model TDM2433E)

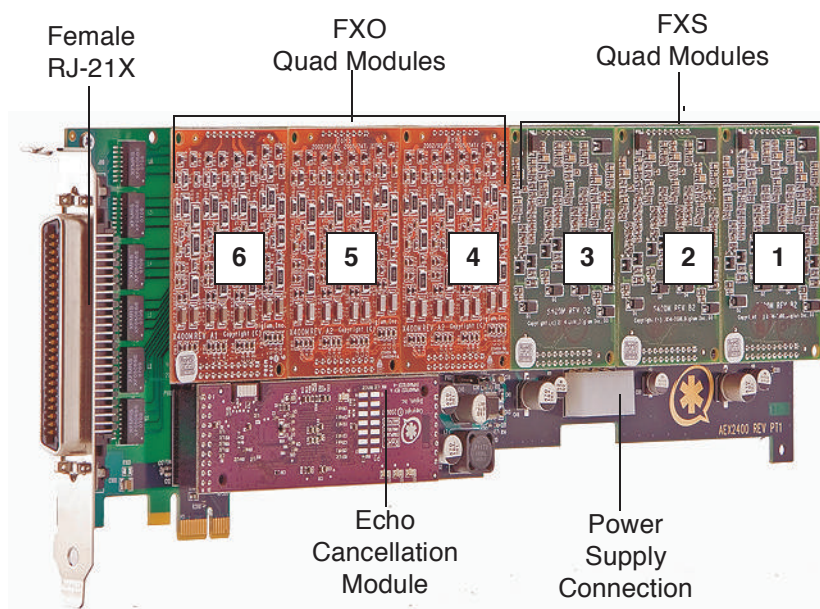

Figure 6: AEX2400 Card (Model TDM2433E)

Card Identification

There are multiple configurations in which a 2400 Series card may be purchased. Each configuration consists of a combination of quad modules and may also include the VPMOCT032 echo cancellation module. See Table 1 on page 25 for a list of the most common TDM2400P configurations. See Table 2 on page 26 for a list of the most common AEX2400 configurations. The lists are not complete, but rather an example of the configurations available.

It is easiest to identify your card by understanding the naming scheme for each card. The first two digits are the maximum port count of the card. The third digit is the number of FXS (station) modules present on the card. The fourth digit is the number of FXO (office) modules present on the card.

Table 1: Example TDM2400P Card Configurations

Card ID	FXO/FXS Ports
TDM2401B	1 quad FXO module
TDM2406B	6 quad FXO modules
TDM2433B	3 quad FXO modules and 3 quad FXS modules
TDM2451B	5 quad FXS and 1 quad FXO modules
TDM2460B	6 FXS modules

Table 2: Example AEX2400 Card Configurations

Card ID	FXO/FXS Ports
AEX2401B	1 quad FXO module
AEX2406B	6 quad FXO modules
AEX2433B	3 quad FXO modules and 3 quad FXS modules
AEX2451B	5 quad FXS and 1 quad FXO modules
AEX2460B	6 FXS modules

FXS and FXO Connection

The 2400 Series card provides a 50-pin RJ-21X connector for access to the FXS and/or FXO quad modules installed in the six available slots. The diagram in Figure A-1 on page 57 provides the pinout for this connector.



Caution.

Only qualified service personnel should continue with hardware installation and configuration of the 2400 Series card. Users should not attempt to perform these functions themselves.

Slot Compatibility

Check the type of card you received to be sure it is compatible with your PCI slot. To determine which slot you have, identify it by comparing it to those shown in Figure 7 on page 28.

Slot Number:

- 0: AGP Pro Slot
- 1: 64-bit 5.0 volt PCI Slot
- 2: 64-bit 3.3 volt PCI Slot
- 3: 32-bit 5.0 volt PCI Slot
- 4: PCI Express Slot

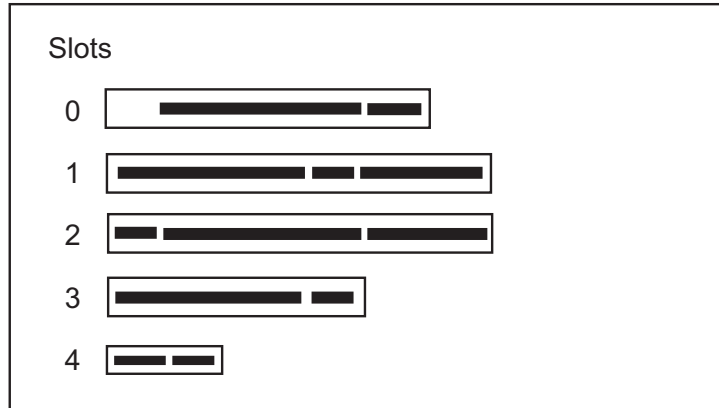

Figure 7: Motherboard Slots

The TDM2400P card is a 32-bit 33MHz card keyed for universal 3.3 volt or 5.0 volt operation and works in any PCI 2.2 (or greater) compliant slot. This means that in the motherboard shown in Figure 7, the TDM2400 card will fit into Slots 1, 2, or 3 (PCI slots), but **will not** fit into Slot 0 (AGP slot) or Slot 4 (PCI Express slot).

The AEX2400 card is a PCI Express card. Slot 4, illustrated above, is a 1 lane (X1) PCI Express compliant slot. The AEX2400 will work in any PCI Express compliant slot, including lane lengths X4, X8, and X16. This means that in the motherboard shown in Figure 7, the AEX2400 will only fit into Slot 4. The AEX2400 **can not** be used in Slots 0 through 3.

Hardware Installation

1. Now that you are acquainted with your card, power down your computer and unplug it from its power source.
2. Attach a static strap to your wrist and open the case.
3. Remove the bracket place holder and insert the card into a PCI (TDM2400P) or PCI Express (AEX2400) slot. See Figure 8.

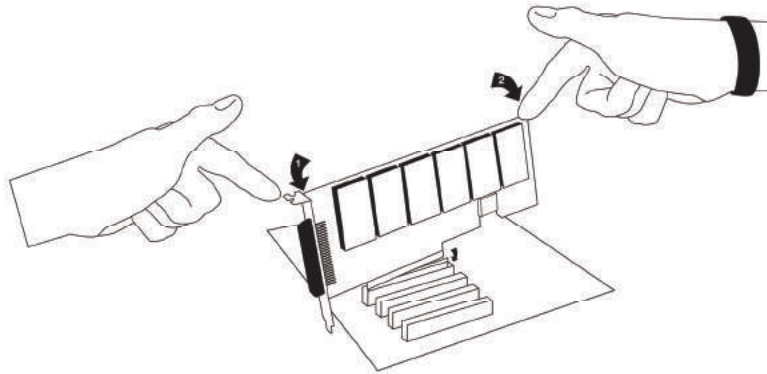

Figure 8: Insert the Card

4. If your card has any FXS quad modules, you will also need to connect the power cable from your computer's power supply to the bottom of the card. Insert a four-pin 12 volt connector (disk drive power supply cable, e.g. hard drive) into the white plastic connector on the bottom of the card. See Figure 9.

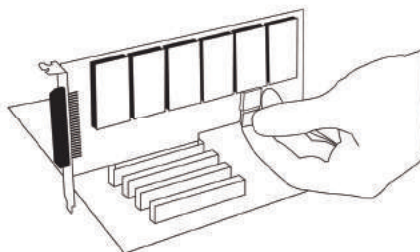

Figure 9: Connect Power for FXS Quad Modules

Many modern PCs and servers do not have either spare or any 12V power connectors. If you have FXS modules on your 2400 Series card and your computer does not have power cables available, then power must be provided to the 2400 Series card by an alternate means. Digium provides a solution to this problem with the optional PWR2400B (available separately). This card is essentially a PCI bracket assembly that takes power from an external DC power supply and routes it to two 15" power cables inside the computer. You must have an available bracket slot to use the PWR2400B (either PCI, PCI Express or AGP).

A strap on the PWR2400B card allows the two power cables to take power from the same DC supply. The PWR2400B comes with one power supply capable of supporting up to 24 FXS ports each, driving heavy loads of up to 5REN. If more than 24 FXS ports with heavy loads are connected to the PWR2400B, then a second Digium power Supply should be purchased. The shorting strap on the PWR2400B should be removed if a second power supply is used.

The PWR2400B does not connect to any bus inside the computer. It may be used wherever there is an available PCI-size bracket such as a PCI, PCI Express, or AGP slot.

Note: The PWR2400B is not intended to supply power to any other device, it is intended only to be used with UL Listed Digium analog cards.

5. Replace the cover to your computer.



Electrical Shock.

To reduce the risk of injury, damage to the unit or your equipment, do not attempt to apply power to the unit while the case is open. Personal injury or damage to the unit could occur if the modules are touched while powered is applied.

6. Plug all outside phone lines to the FXO ports (corresponding to the red modules) and connect all phones to the FXS ports (green modules) as needed using a patch panel or punch block. See Figure A-1 on page 57 for the RJ-21X pin assignments.



Caution.

This unit must be connected to the Telecommunications Network in your country using an approved line cord, e.g.: for Australia use only line cords complying with AS/CA S008:2010.



Caution.

Only connect regulatory equipment (approved for use in your specific country) to the telecommunications network voltage circuit ports.

Software Installation

Digium hardware requires drivers and libraries that are not integrated with the Linux kernel. Digium hardware is only supported under Linux. Digium recommends CentOS, Debian, Red Hat, and Ubuntu distributions of Linux. However, many other distributions are supported by Digium Technical Support.

Digium's software, including drivers and application software, may be obtained from Digium's download server at:

<http://downloads.digium.com>

For an introduction to Asterisk, Digium's telephony software, including additional information on its configuration, setup, and features, please refer to:

<http://www.asterisk.org>

For the latest information on setting up and configuring DAHDI drivers for your Digium hardware product, please refer to the latest release of this manual which is available from the product-specific documentation section at:

<http://www.digium.com>

To install your 2400 Series card, you will need:

- Linux 2.6 kernel headers
- Development libraries and headers for ncurses
- Development libraries and headers for zlib and openssl
- Development libraries and headers for newt
- GCC and standard software build tools

It is recommended that you use the most recent version of the Asterisk, DAHDI, and libpri software for the best results. If you have previously

installed any of these, Digium recommends that you upgrade to the latest “-current” version of each.

Note: If you are using the 1.4.x series of Asterisk, you will need Asterisk 1.4.22 or newer.

1. After the machine has booted to Linux, log in and execute the following command to list the devices detected by the PCI bus:

```
# lspci -n
```

Confirm that the output from **lspci** lists a device with Digium’s PCI vendor ID which is “d161”. The screen output should be similar to the following:

```
0000:01:00.0 0200:d161:<card identifier>
```

Note: The output from **lspci** may or may not state “Unknown device”. If it does, this does not indicate a problem.

In the PCI device listing shown above, <card identifier> will be populated with one of the identifiers listed in the table below.

Table 3: Card Identifiers

Model	Identifier
TDM2400P	2400
AEX2400	8003

A Digium 2400 Series (TDM2400P/AEX2400) card identifier should be listed. If a matching card identifier is not listed, then your machine is not PCI 2.2 (or higher) or PCI Express compatible, and the card will not work with your motherboard.

2. Download the latest DAHDI drivers with tools. DAHDI is available for download from:

<http://downloads.digium.com/pub/telephony/dahdi-linux-complete>

```
# wget http://downloads.digium.com/pub/telephony/  
dahdi-linux-complete/dahdi-linux-complete-  
current.tar.gz
```

3. Expand the downloaded file, compile its contents, and install the drivers and tools. Substitute the version of DAHDI for the X.X.X in the command lines below.

```
# tar -zxvf dahdi-linux-complete-current.tar.gz
# cd dahdi-linux-complete-X.X.X+X.X.X
# make
# make install
# make config
```

Note: Executing ‘make config’ will install an init script and symlinks which will allow you to start and stop DAHDI as a service.

Installing Asterisk

If you wish to use Asterisk with your new hardware, you can follow the instructions below.

1. Download the latest release version of Asterisk, either 1.4.22 (or later), 1.6.0.1 (or later), or 1.8.0 (or later). Substitute the version of Asterisk for the X.X in the command below. Asterisk is available for download from:

<http://downloads.digium.com/pub/telephony/asterisk>

```
# wget http://downloads.digium.com/pub/telephony/  
asterisk/asterisk-X.X-current.tar.gz
```

2. Expand the downloaded file, compile its contents, and install the application. Substitute the version of Asterisk for the the X.X and X.X.X in the command lines below.

```
# tar -zxvf asterisk-X.X-current.tar.gz  
# cd asterisk-X.X.X/  
# ./configure  
# make menuselect  
# make  
# make install
```

3. If this is the first Asterisk installation on this system, you should install the sample configuration files. To do this, run:

```
# make samples
```

Note: Running this command will overwrite, after making a backup copy, any older Asterisk configuration files that you have in the `/etc/asterisk` directory.

If your installation has failed, it may be because you are missing one or more of the build dependencies, the kernel headers, or the development tools. Please contact your reseller where the card was purchased, or call Digium Technical Support (+1.256.428.6161) for assistance.

Complete instructions for installing Asterisk are available at www.asterisk.org.

Chapter 3 Configuration

The 2400 Series cards have a variety of configuration options. This chapter provides sample configurations to demonstrate customizing the Asterisk software to meet your individual needs. Each section explains basic options as examples. Once you have familiarized yourself with the samples, you can edit the configuration files to meet your specific needs.

Driver Configuration

1. Begin by opening the **system.conf** file from the **/etc/dahdi** directory.
2. Specify the two letter country code for your loadzone and defaultzone. This will preload tone zone data and specify a default tone zone for your interfaces.

The following is a typical setup for a telco in the US:

```
loadzone = us
defaultzone = us
```

3. Specify the channel definitions. The format is:

`<device> = <channel list>`

A list of valid devices are specified in the sample system.conf file.

If your card has any red FXO quad modules, add the following to system.conf:

`fxsks =`

fxsks uses kewlstart signalling, which is loopstart signalling with disconnect supervision. For example, a TDM2406E card would be configured as the following:

`fxsks = 1-24`

OR

`fxsks = 1, 2, 3, 4, 5, 6, 7, 8, 9, 10, 11, 12, 13, 14, 15, 16, 17, 18, 19, 20, 21, 22, 23, 24`

You should have identified the type of 2400 Series card when you received it. If you are not sure, refer to **Module Identification** on page 22 for assistance.

Note: The 2400 Series cards do not support Ground Start signaling.

4. If your card has any green FXS quad modules, add the following:

fxoks =

fxoks uses kewlstart signalling, which is loopstart signalling with disconnect supervision. For example, a TDM2460E card would be configured as the following:

fxoks = 1-24

OR

**fxoks = 1,2,3,4,5,6,7,8,9,10,11,12,13,14,15,16,17,
18,19,20,21,22,23,24**

5. An example TDM2433E card configuration would be:

fxoks = 1-12

fxsks = 13-24

OR

fxoks = 1,2,3,4,5,6,7,8,9,10,11,12

fxsks = 13,14,15,16,17,18,19,20,21,22,23,24

6. DAHDI uses modular echo cancellers that are configured per channel. The echo cancellers are compiled and installed as part of the dahdi-linux package. You can specify the echo canceller to be used for each channel. The default behavior is for there to be no echo canceller on any channel. So, it is very important that you specify one in the

system.conf file if you do not have hardware echo cancellers and need echo cancellation. The format is:

```
echocanceller = <echocanceller name>,<channel(s)>
```

A list of valid echo cancellers are specified in the sample system.conf file.

The following is a typical setup using software-based echo cancellation:

```
echocanceller = mg2,1-23
```

7. Load DAHDI drivers into the kernel using the **modprobe** utility. The appropriate driver for the 2400 Series cards is **wctdm24xxp**. Users should use the following modprobe command:

```
# modprobe wctdm24xxp
# dahdi_cfg -vv
# dmesg
```

```
dahdi: Telephony Interface Registered on major 196
dahdi: Version: 2.1.0.4
Port 1: Installed -- AUTO FXS/DPO
Port 2: Installed -- AUTO FXS/DPO
Port 3: Installed -- AUTO FXS/DPO
Port 4: Installed -- AUTO FXS/DPO
Port 5: Installed -- AUTO FXS/DPO
Port 6: Installed -- AUTO FXS/DPO
Port 7: Installed -- AUTO FXS/DPO
Port 8: Installed -- AUTO FXS/DPO
Port 9: Installed -- AUTO FXS/DPO
Port 10: Installed -- AUTO FXS/DPO
Port 11: Installed -- AUTO FXS/DPO
Port 12: Installed -- AUTO FXS/DPO
Port 13: Installed -- AUTO FXO (FCC mode)
Port 14: Installed -- AUTO FXO (FCC mode)
Port 15: Installed -- AUTO FXO (FCC mode)
Port 16: Installed -- AUTO FXO (FCC mode)
Port 17: Installed -- AUTO FXO (FCC mode)
Port 18: Installed -- AUTO FXO (FCC mode)
Port 19: Installed -- AUTO FXO (FCC mode)
Port 20: Installed -- AUTO FXO (FCC mode)
Port 21: Installed -- AUTO FXO (FCC mode)
Port 22: Installed -- AUTO FXO (FCC mode)
Port 23: Installed -- AUTO FXO (FCC mode)
Port 24: Installed -- AUTO FXO (FCC mode)
VPM100: Not Present
VPMADT032 Loading firmware... Success
Booting VPMADT032
VPMADT032: Present and operational (Firmware version 107)
Found a Wildcard TDM: Wildcard TDM2400P (24 modules)
```

Figure 10: Example dmesg Screen Shot

Note: Output as shown above may vary depending on the 2400 Series card you use.

Configuring Card Features

You will need to modify the **chan_dahdi.conf** file which is located in the `/etc/asterisk` directory in order to configure the essential features of your card. This file is the configuration layer between DAHDI and Asterisk.

The following is a sample configuration for a TDM2422B card. You can place this at the bottom of your **chan_dahdi.conf** file.

```
;General options
usecallerid = yes
hidecallerid = no
callwaiting = yes
threewaycalling = yes
transfer = yes
echocancel = yes
echocancelwhenbridged = yes
rxgain = 0.0
txgain = 0.0
;FXS Modules
group = 1
signalling = fxo_ks
context = Internal
channel = 1-8

;FXO Modules
group = 2
echocancel = yes
signalling = fxs_ks
context = Incoming
```

`channel = 9-16`

Users of Digium's hardware echo cancellation module, the VPMOCT032, should set the echocancel option to "yes." The module will automatically configure itself to run at full capacity, 1024 taps (128ms), on each channel.

Users without the VPMOCT032 using open source echo cancelers included with DAHDI should configure echocancel to the values 128 (16ms) or 256 (32ms). Setting "yes" will default the option to 128 (16ms).

Users who have not purchased a 2400 Series card with the hardware echo cancellation module are encouraged to take advantage of Digium's High Performance Echo Canceler software. This commercially licensed software, which is made available at no charge to in-warranty Digium analog interface card customers, provide toll quality echo cancellation, performed on the host CPU, at up to 1024 taps (128ms) per channel. For further details about HPEC, please refer to the Digium website here:

<http://www.digium.com/en/products/software/hpec.php>

When HPEC is enabled, users may set the value of the echocancel parameter to any of the following values:

128 - 16ms

256 - 32ms

512 - 64ms

1024 - 128ms

Note: Higher values will result in dramatically increased CPU consumption. In order to optimize system performance, users are encouraged to choose the minimum value required to cancel their echo.

Voicemail

Open **voicemail.conf** and find the following line at the bottom:

```
[default]
1234 => 4242,Mark Spencer,root@localhost
```

In this example, **1234** is the mailbox number, **4242** is the password, **Mark Spencer** is the person's name, and **root@localhost** is his email address.

You can add extensions by adding the following:

```
1000 => 1234,Moose Member,moose@digium.com
2000 => 1234,Bill Savage,bsavage@digium.com
```

Dial Plan

Open **extensions.conf**, which contains a large, complex sample dial plan. In this step, you will configure a basic dial plan to enable you to send and receive calls. Go to the bottom of the file and add the following lines:

```
[Internal]
exten => 1000,1,Dial(DAHDI/1,20,rt)
exten => 1000,2,Voicemail(1000,u)
exten => 1000,102,Voicemail(1000,b)

exten => 2000,1,Dial(DAHDI/2,20,rt)
exten => 2000,2,Voicemail(2000,u)
exten => 2000,102,Voicemail(2000,b)

exten => 8500,1,VoiceMailMain
exten => 8501,1,MusicOnHold

exten => _9.,1,Dial(DAHDI/g2/www${EXTEN:1})
exten => _9.,2,Congestion

[Incoming]
exten => s,1,Answer
exten => s,2,Dial(DAHDI/g1,20,rt)
exten => s,3,Voicemail(1000,u)
exten => s,103,Voicemail(1000,b)
```

In this example, there are two internal extensions (1000 and 2000), a number to check voicemail (8500), a number to listen to music-on-hold, (8501), and a prefix to dial to get an outside line (9). It is configured to accept incoming calls over the FXO, rings phones 1 and 2, and route to voicemail box 1000.

Testing Your Configuration

1. Start Asterisk by typing:

```
asterisk
```

2. Connect to Asterisk and view the output by typing:

```
asterisk -vvvr
```

3. Dial tone should be present on phones connected to the FXS ports. Test your configuration by placing an outgoing call, placing a call from extension 1 to 2, or receiving an incoming call. Successful completion of these tasks indicates your configuration is working properly.

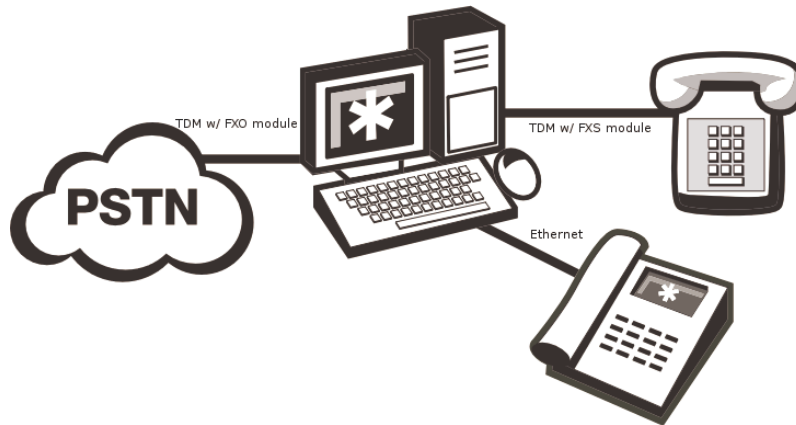

Figure 11: Sample Application

Note: More detailed information is provided at the Asterisk website (www.asterisk.org), as well as the Digium Knowledge Base (kb.digium.com). You may also obtain assistance by contacting Digium Technical Support (+1.256.428.6161) or visiting the website at www.digium.com.

Chapter 4 FXS and FXO Explained

Identification

There are multiple standard configurations in which a 2400 Series card may be purchased. Each configuration consists of one to six FXS and/or FXO modules. These modules are identified by their color.

- **FXS** - Foreign Exchange Station (Green Modules)
- **FXO** - Foreign Exchange Office (Red Modules)

This chapter provides an in-depth review of the two module types and their uses within your Asterisk server.

Note: Only qualified service personnel should install the card. Users should not attempt to perform this function themselves.

FXS Module

The FXS module allows a 2400 Series card to initiate and send ringing voltage to an FXO device such as an analog telephone.

FXO Module

The FXO module allows the 2400 Series card to terminate analog telephone lines (POTS).

Because of the modular design, you can activate additional ports at any time with more FXS or FXO daughter cards. The FXO module passes all the call features any standard analog telephone line will support. The phone receiving the call is the last FXO device in the chain. When it receives voltage from an FXS device, the phone rings.

Using Your 2400 Series Card

Connect an outside line to an FXO port on your Asterisk server to receive voltage from the outside line.

Connect phones to FXS ports on your Asterisk server. The recommended maximum distance from an FXS module to its connected device is 1,500 ft. (457m). When the FXO module in your Asterisk Server receives the voltage, it will then generate voltage using the FXS module and send it to your analog phone.

Note: An analog phone line originating from an FXS module must remain inside the same building as the FXS module. In addition, an analog phone line originating from an FXS module must not be bundled with a line or lines that go outside the building where the FXS module is located.



Caution.

FXS modules are not equipped with lightning protection and should not be exposed to high voltage. Lightning or high voltage can cause damage to an FXS module. Damage caused by lightning or high voltage will void the product warranty.

Chapter 5 Troubleshooting

This chapter provides frequently asked questions and possible resolutions as identified by Digium Technical Support. Multiple resources are available to obtain more information about Asterisk and Digium products. Please visit both www.digium.com and www.asterisk.org for more information.

The FXO module never seems to hang-up the line. How do I set it to hang-up?

Set **busydetect = yes** and **busycount = 10** in the **chan_dahdi.conf** for your channels. This will cause the line to hang-up by listening for a consecutive number of busy tones. Upon editing **chan_dahdi.conf**, you will need to restart Asterisk.

I have echo problems on my FXO modules and I've tried the different echo cancellation algorithms in dahdi_config.h, tried tweaking the gains, and still nothing works. What can I do?

Run the fxotune utility with the -i option (fxotune -i 4). It should discover which DAHDI channels are FXO modules and tune them accordingly. Be warned however, it takes a significant amount of time for each module to tune. A conservative estimate would be somewhere around 2-3 minutes for each module. You only have to tune the channels once for each line. The fxotune utility will store the calibration settings in /etc/fxotune.conf. You will need to configure your system to run fxotune with the -s flag (fxotune -s) during the Linux boot sequence in order to initialize the previously discovered values which are stored in fxotune.conf. A recommendation is to put 'fxotune -s' in your distribution's startup scripts at some point after the DAHDI module loads and before Asterisk executes.

Note: The digit after the -i option is the digit that will break dialtone on the line.

There is a slight echo. How can I adjust the sound quality?

There are several options available to correct this. Each involves editing the **chan_dahdi.conf** file. Be sure to restart Asterisk upon completion.

1. Adjust **echocancel = yes** to one of the following values: **32, 64, 128, or 256**.
2. You can also set **echotraining = yes**.
3. You can also adjust the **rxgain** and the **txgain**, although it is only recommended to shift between **-5** and **5**.

How can I enable more features?

To view all of the options available to add to your dial plan, type the following commands from within Asterisk:

```
*CLI> core show applications
*CLI> core show functions
```

Digium also offers services to help configure and add features you might need. Contact Digium Technical Support (+1.256.428.6161) for more information.

Common Fixes

1. Check to see if the X Window System (*e.g.* X.Org Server) is running by entering the following:

```
# ps aux | grep X
```

If the X Window System is running, stop the application since it may cause a conflict with Asterisk.

2. Check to see if your PATA IDE hard drives are running with DMA levels set. Advance user can perform an **hdparm** on your hard drive interface.



Use hdparm with caution as the man page states that hard drive corruption can occur when using incorrect settings. Please review the man page for hdparm and make sure you understand the risks before using this tool.

Check the current mode using this command:

```
hdparm -vi /dev/[IDE Device]
```

Use this command to set the drives into UDMA2 mode:

```
hdparm -d 1 -X udma2 -c 3 /dev/[IDE Device]
```

If you are still having problems, contact your reseller from which the card was purchased, or Digium Technical Support (+1.256.428.6161).

Where can I find answers to additional questions?

There are several places to inquire for more information about Asterisk Digium products:

1. Digium Technical Support (+1.256.428.6161), or Toll Free in the U.S. (1.877.344.4861), is available 8am-5pm Central Time (GMT -6), Monday - Friday.
2. Asterisk users mailing list (asterisk.org/lists.digium.com).
3. IRC channel **#asterisk** on (irc.freenode.net).

Subscription Services Program

Digium is dedicated to supporting your Asterisk system by offering full technical support through our Subscription Services Program. Through this program, you can be at ease knowing that your business will always have access to the Asterisk experts. Pricing on Subscription Services may be obtained from your nearest reseller or you may call Digium Sales for referral to your nearest reseller at +1.256.428.6000 or e-mail sales@digium.com.

Appendix A Pin Assignments

The 2400 Series card provides a 50-pin RJ21 connector for FXO and FXS access.

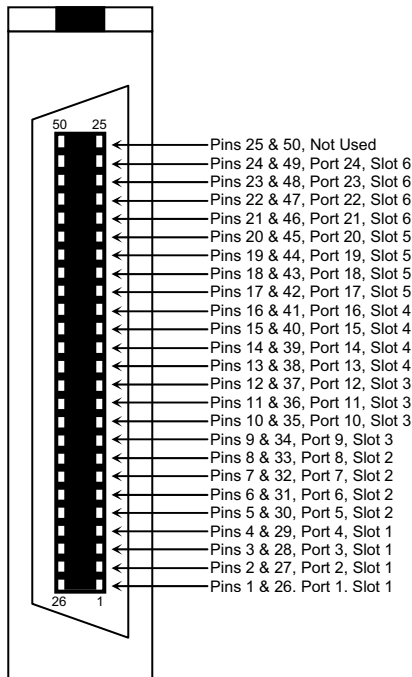

Figure A-1: RJ-21 Port Connector

Note: Pins 1-24 are 'tip' for channels 1-24. Pins 26-49 are 'ring' for channels 1-24.

Appendix B Specifications

This appendix provides specifications, required environmental conditions, and maximum power consumption for the 2400 Series cards.

Physical.

Size: 12.28" × 4.2" × 0.68" (31.19 x 10.67 x 1.72 cm)
PCB size, does not include the PCI bracket or retainer.

Weight: 5.8 oz (164.43gm) with no modules loaded. Each quad module adds 1 oz (28.3gm)

Interfaces.

Local Loop Access: Industry standard 50-pin RJ-21 (amphenol).

Note: RJ-21 cables and patch panels are available from Digium.

FXS modules are not equipped with lightning protection and should not be exposed to high voltage. Lightning or high voltage can cause damage to an FXS module. Damage caused by lightning or high voltage will void the product warranty.

The recommended maximum distance from an FXS module to its connected device is 1,500 ft. (457m).

PCI Bus (TDM2400P): 3.3V or 5V bus slot, full length full height, 33MHz minimum bus speed, compliant with PCI 2.2 or greater.

(AEX2400) - PCI-E X1, compliant with PCI-E X1 1.0 or greater.

Additional Power: Four-pin 12V connector for FXS power supply
(required only if FXS modules are installed)

Environment.

Temperature: 0 to 50° C (32 to 122° F) operation
 -20 to 70° C (4 to 158° F) storage

Humidity: 10 to 90% non-condensing

Note: Operating temperature is limited to 0 to 40° C (32 to 104° F)
when used with optional PWR2400B Power Bracket.

Hardware and Software Requirements.

800-Mhz Pentium III or better

64MB RAM

Available PCI or PCI-Express Slot (as described previously)

Table B-1: Maximum Power Consumption

Model	Power
3.3V All TDM models	1.0 Watt
3.3V All AEX "B" models	4.0 Watts
3.3V All AEX "E" models	4.7 Watts
5V All TDM models	9.0 Watts
5V All AEX models	0.0 Watts
12V AEX/TDM2406E into 1REN	11.0 Watt
12V AEX/TDM2433E into 2REN	12.0 Watts
12V AEX/TDM2433E into 3REN	15.0 Watts
12V AEX/TDM2433E into 4REN	17.5 Watts
12V AEX/TDM2433E into 5REN	20.0 Watts

Appendix C Glossary and Acronyms

ANSI *American National Standards Institute*

An organization which proposes and establishes standards for international communications.

asynchronous

Not synchronized; not timed to an outside clock source. Transmission is controlled by start bits at the beginning and stop bits at the end of each character. Asynchronous communications are often found in internet access and remote office applications.

attenuation

The dissipation of a transmitted signal's power as it travels over a wire.

bandwidth

The capacity to carry traffic. Higher bandwidth indicates the ability to transfer more data in a given time period.

bit

The smallest element of information in a digital system. A bit can be either a zero or a one.

bps *bits per second*

A measurement of transmission speed across a data connection.

broadband

Broadband transmission shares the bandwidth of a particular medium (copper or fiber optic) to integrate multiple signals. The channels take up different frequencies on the cable, integrating voice, data, and video over one line.

channel

A generic term for an individual data stream. Service providers can use multiplexing techniques to transmit multiple channels over a common medium.

Cat5

Category of Performance for wiring and cabling. Cat 5 cabling support applications up to 100 MHz.

Cat5E

Category of Performance for wiring and cabling. Category 5 Enhanced wiring supports signal rates up to 100 MHz but adheres to stricter quality specifications.

CLEC *competitive local exchange carrier*

A term for telephone companies established after the Telecommunications Act of 1996 deregulated the LECs. CLECs compete with ILECs to offer local service. See also *LEC* and *ILEC*.

CO *central office*

The CO houses local switching equipment. All local access lines in a particular geographic area terminate at this facility (which is usually owned and operated by an ILEC).

CPE *customer premises equipment*

Terminal equipment which is connected to the telecommunications network and which resides within the home or office of the customer. This includes telephones, modems, terminals, routers, and television set-top boxes.

DAHDI *Digium Asterisk Hardware Device Interface*

A telephony project dedicated to implementing a reasonable and affordable computer telephony platform into the world marketplace. Also, the collective name for the Digium-provided drivers for Digium telephony interface products.

DS0 *Digital Signal, Level 0*

A voice grade channel of 64 Kbps. The worldwide standard speed for digitizing voice conversation using PCM (Pulse Code Modulation).

DS1 *Digital Signal, Level 1*

1.544 Mbps in North America (T1) and Japan (J1) -up to 24 voice channels (DS0s), 2.048 Mbps in Europe (E1) - up to 32 voice channels (DS0s). DS1/T1/E1 lines are part of the PSTN.

DS3 *Digital Signal, Level 3*

T3 in North America and Japan, E3 in Europe. Up to 672 voice channels (DS0s). DS3/T3/E3 lines are not part of the PSTN

DTMF *Dual Tone Multi-Frequency*

Push-button or touch tone dialing.

E1

The European equivalent of North American T1, transmits data at 2.048 Mbps, up to 32 voice channels (DS0s).

E3

The European equivalent of North American T3, transmits data at 34.368 Mbps, up to 512 voice channels (DS0s). Equivalent to 16 E1 lines.

EMI *Electromagnetic Interference*

Unwanted electrical noise present on a power line

full duplex

Data transmission in two directions simultaneously.

FXO *Foreign Exchange Office*

Receives the ringing voltage from an FXS device. Outside lines are connected to the FXO port on your 2400 Series card.

FXS *Foreign Exchange Station*

Initiates and sends ringing voltage. Phones are connected to the FXS ports on the 2400 Series card.

G.711

A recommendation by the Telecommunication Standardization Sector (ITU-T) for an algorithm designed to transmit and receive mulaw PCM voice and A-law at a digital bit rate of 64 Kbps. This algorithm is used for digital telephone sets on digital PBX.

G.723.1

A recommendation by the Telecommunication Standardization Sector (ITU-T) for an algorithm designed to transmit and receive audio over telephone lines at 6.3 Kbps or 5.3 Kbps.

G.729a

A recommendation by the Telecommunication Standardization Sector (ITU-T) for an algorithm designed to transmit and receive audio over telephone lines at 8 Kbps.

H.323

A recommendation by the Telecommunication Standardization Sector (ITU-T) for multimedia communications over packet-based networks.

IAX *Inter-Asterisk eXchange*

The native VoIP protocol used by Asterisk. It is an IETF standard used to enable VoIP connections between Asterisk servers, and between servers and clients that also use the IAX protocol.

iLBC *internet Low Bitrate Codec*

A free speech codec used for voice over IP. It is designed for narrow band speech with a payload bitrate of 13.33 kbps (frame length = 30ms) and 15.2 kbps (frame length = 20 ms).

ILEC *incumbent local exchange carrier*

The LECs that were the original carriers in the market prior to the entry of competition and therefore have the dominant position in the market.

interface

A point of contact between two systems, networks, or devices.

ISO *International Standards Organization*

LED *light-emitting diode*

Linux

A robust, feature-packed open source operating system based on Unix that remains freely available on the internet. It boasts dependability and offers a wide range of compatibility with hardware and software. Asterisk is supported exclusively on Linux.

loopback

A state in which the transmit signal is reversed back as the receive signal, typically by a far end network element.

MGCP *Media Gateway Control Protocol*

multiplexing

Transmitting multiple signals over a single line or channel. FDM (frequency division multiplexing) and TDM (time division multiplexing) are the two most common methods. FDM separates signals by dividing the data onto different carrier frequencies, and TDM separates signals by interleaving bits one after the other.

MUX *multiplexer*

A device which transmits multiple signals over a single communications line or channel. See multiplexing.

PBX *private branch exchange*

A smaller version of a phone company's large central switching office. Example: Asterisk.

PCI *peripheral component interconnect*

A standard bus used in most computers to connect peripheral devices.

POP *point of presence*

The physical connection point between a network and a telephone network. A POP is usually a network node serving as the equivalent of a CO to a network service provider or an interexchange carrier.

POTS *plain old telephone service*

The public switched telephone network (PSTN) is the network of the world's public circuit-switched telephone networks. Originally a network

of fixed-line analog telephone systems, the PSTN is now almost entirely digital, and now includes mobile as well as fixed telephones.

PPP *point-to-point protocol*

Type of communications link that connects a single device to another single device, such as a remote terminal to a host computer.

PSTN *public switched telephone network*

A communications network which uses telephones to establish connections between two points. Also referred to as the dial network.

QoS *quality of service*

A measure of telephone service, as specified by the Public Service Commission.

RJ11

A six-pin jack typically used for connecting telephones, modems, and fax machines in residential and business settings to PBX or the local telephone CO.

SIP *Session Initiation Protocol*

An IETF standard for setting up sessions between one or more clients. It is currently the leading signaling protocol for Voice over IP, gradually replacing H.323.

T1

A dedicated digital carrier facility which transmits up to 24 voice channels (DS0s) and transmits data at 1.544 Mbps. Commonly used to carry traffic to and from private business networks and ISPs.

T3

A dedicated digital carrier facility which consists of 28 T1 lines and transmits data at 44.736 Mbps. Equivalent to 672 voice channels (DS0s).

TDM *time division multiplexer*

A device that supports simultaneous transmission of multiple data streams into a single high-speed data stream. TDM separates signals by interleaving bits one after the other.

telco

A generic name which refers to the telephone companies throughout the world, including RBOCs, LECs, and PTTs.

tip and ring

The standard termination on the two conductors of a telephone circuit; named after the physical appearance of the contact areas on the jack plug.

twisted pair

Two copper wires commonly used for telephony and data communications. The wires are wrapped loosely around each other to minimize radio frequency interference or interference from other pairs in the same bundle.

V *volts*

VoIP *Voice over IP*

Technology used for transmitting voice traffic over a data network using the Internet Protocol.